

Control valves with pneumatic actuators up to 350°C

PN 16-40 **3.1.1**

Flanged connection
 PN 16-40
 Cast iron
 Spheroidal graphite
 Cast steel
 Stainless steel

with pneumatic actuators
 PA-N160 • PA-N300 • PA-N540
 PA-N1080 • PA-N2160

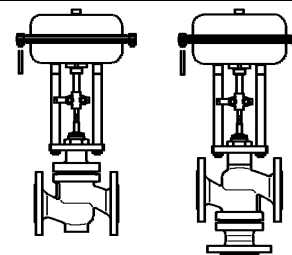

BR216
BR225
BR240S
BR240E

BR316
BR325
BR340S
BR340E

Features

- Suitable in building and process engineering for various mediums 0...+200°C
- Suitable with stuffing box extension or stem seal with stainless steel bellow to -10...+350°C and for valves made of stainless steel to -30...+350°C
- Suitable with stem heater for water with antifreeze compounds down to -10°C and for valves made of stainless steel to -30°C
- Actuators with high thrust and short actuation time
- Mode of operation: spring opens / air closes or opens

Technical data valve

Series	BR216	BR225	BR240S	BR240E
Form	Two-way			
Diameter nominal	DN 125 – DN 300	DN 15 – DN 200 ¹⁾	DN 15 – DN 300	
Pressure rating	PN 16	PN 16 / PN 25 / PN 40	PN 40	
Body	Cast iron EN-JL1040	Spheroidal graphite EN-JS1024	Cast steel 1.0619+N	Stainless steel 1.4408
Plug	CrNi-steel 1.4057			CrNi-steel 1.4571
Stem	CrMo-steel 1.4122			CrNi-steel 1.4571
Characteristic	≤ DN 50: equal % ≥ DN 65: eq. % mod.		Option: linear	
	Perforated plug: equal %		Option: linear	
Stroke mm	20 (DN 15 – DN 40) 30 (DN 50 – DN 65) 50 (DN 80 – DN 100) 60 (DN 125 – DN 200) 80 (DN 250 – DN 300)			
Rangeability	≥ 50:1			
Connection type	Flanges acc. EN 1092-2 Typ 21		Flanges acc. EN 1092-1 Typ 21	
Pressure, Temp.	Acc. EN 1092 part 2		Acc. EN 1092 part 1	

¹⁾ DN 150: PN 16 or PN 25
 DN 200: PN 16

Control valves with pneumatic actuators up to 350°C

PN 16-40 **3.1.1**

Flanged connection
PN 16-40
Cast iron
Spheroidal graphite
Cast steel
Stainless steel

with pneumatic actuators
PA-N160 • PA-N300 • PA-N540
PA-N1080 • PA-N2160

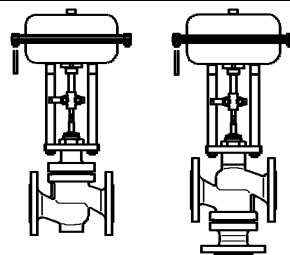

BR216
BR225
BR240S
BR240E

BR316
BR325
BR340S
BR340E

Series	BR316	BR325	BR340S	BR340E
Form	Three-way			
Diameter nominal	DN 125 – DN 300	DN 15 – DN 200 ¹⁾	DN 15 – DN 300	
Pressure rating	PN 16	PN 25	PN 40	
Body	Cast iron ²⁾ EN-JL1040	Spheroidal graphite EN-JS1024	Cast steel 1.0619+N	Stainless steel 1.4408
Plug	CrNi-steel 1.4057			CrNi-steel 1.4571
Stem	CrMo-steel 1.4122			CrNi-steel 1.4571
Characteristic	≤ DN 40: A→AB equal % Option: linear B→AB linear ≥ DN 50: A→AB eq. % mod. Option: linear B→AB linear			
Stroke mm	20 (DN 15 – DN 40) 30 (DN 50 – DN 65) 50 (DN 80 – DN 100) 60 (DN 125 – DN 200) 80 (DN 250 – DN 300)			
Rangeability	≥ 50:1			
Connection type	Flanges acc. EN 1092-2 Typ 21		Flanges acc. EN 1092-1 Typ 21	
Pressure, Temp.	Acc. EN 1092 part 2		Acc. EN 1092 part 1	

Function: BR216/225/240S/240E as two-way valve
BR316/325/340S/340E as mixing valve or
BR316/325/340S/340E as diverting valve with reduced closing pressure

Face to face dimension: Acc. EN 558-1 basic series 1

Leakage rate: EN 1349 – seat-leakage IV L1 (≤ 0.01% of kvs-value)

Stem sealing: O-rings made of EPDM 0...+180°C chilled and hot-water with max. 50% antifreeze and anti-corrosive compounds: glycol, ethylene glycol, mono ethylene, ethanol, methyl alcohol, glycerine, antifrogen[®] N+L

O-rings made of FKM 0...+200°C media based on mineral oil

O-rings made of Fluoraz[®] 0...+200°C hot water, steam, oil, acids and lye

Graphite-Packing 0...+350°C ³⁾ hot water, steam, oil, acids and lye

¹⁾ DN 150: PN 16 or PN 25
DN 200: PN 16

²⁾ Due to a change in material, we reserve the right to supply valves up to DN 100 in higher grade spheroidal graphite EN-JS1024

³⁾ only in combination with stuffing box extension or stem seal with stainless steel bellow

3.1.1 Phone +49 (0) 52 07 / 89 03 - 0
Fax +49 (0) 52 07 / 89 03 - 80
2/14 e-Mail b-a@hora.de
Internet www.hora-ba.com

Holter Regelarmaturen GmbH & Co. KG
Helleforthstraße 58-60
33758 Schloß Holte-Stukenbrock
Germany



Excellence is our standard

Flanged connection
PN 16-40
Cast iron
Spheroidal graphite
Cast steel
Stainless steel

with pneumatic actuators
PA-N160 • PA-N300 • PA-N540
PA-N1080 • PA-N2160

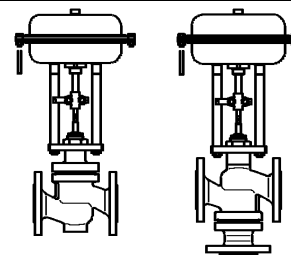

BR216
BR225
BR240S
BR240E

BR316
BR325
BR340S
BR340E

Valve variant and accessories

for two-way and three-way valves:

- Housing connecting flanges: with groove acc. to EN 1092-1 type D,
with socket acc. to EN 1092-1 type F,
with spigot acc. to EN 1092-1 type E
- Body and plug seat grounded in, EN 1349 – seat-leakage IV-S1 L1 ($\leq 0.0005\%$ of kvs-value)
- Plug with soft sealing made of NBR, EPDM, PTFE; EN 1349 – seat-leakage VI G1 (tight sealing)
- Stem heater: 24 VAC, 50 Hz
 $P_{max.} \approx 200 \text{ VA} / P_N \approx 45 \text{ VA}$
S1 100% ED, IP 54
- Transformer for stem heater: 230/24 VAC, 50 Hz
- Stem seal with stainless steel bellow: for valves made of cast iron -10°C...+200°C
for valves made of spheroidal graphite
and cast steel -10°C...+350°C
for valves made of stainless steel -30°C...+350°C
Stuffing box made of graphite
Stuffing box made of graphite
- Stuffing box extension: 100 mm
for valves made of spheroidal graphite
and cast steel -10°C...+350°C
for valves made of stainless steel -30°C...+350°C
- Epoxy resin special varnish as a corrosion resistant in case of condensed water, max. 80°C ¹⁾
- technical silicon free version, max. 180°C
- oil and fat free for oxygen application

only for two-way valves:

- Screwed seat: for valves made of cast iron, spheroidal graphite and cast steel made of 1.4122,
unhardened or hardened
- for valves made of stainless steel made of 1.4571
- Perforated plug: for valves made of cast iron, spheroidal graphite and cast steel made of 1.4057,
unhardened or hardened
- for valves made of stainless steel made of 1.4571
- Housing seat SKWAM plated or Stellite 6 plated ²⁾
- Balanced plug, max. operating temperature 200°C

Schnittzeichnung

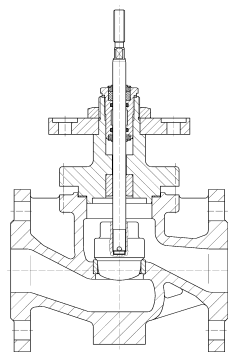

BR216/225/240S/240E

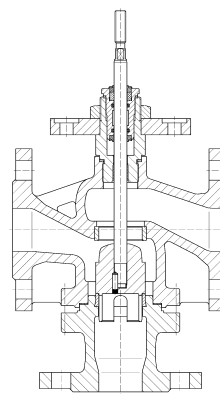

BR316/325/340S/340E

¹⁾ except valves made of stainless steel

²⁾ only for valves made of spheroidal graphite and stainless steel

Control valves with pneumatic actuators up to 350°C

PN 16-40 **3.1.1**

Flanged connection
PN 16-40
Cast iron
Spheroidal graphite
Cast steel
Stainless steel

with pneumatic actuators
PA-N160 • PA-N300 • PA-N540
PA-N1080 • PA-N2160

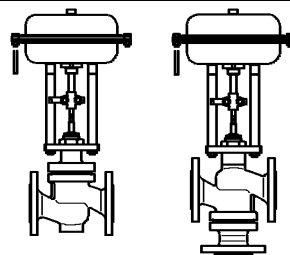

BR216
BR225
BR240S
BR240E

BR316
BR325
BR340S
BR340E

Technical data actuator PA-N160 – PA-N2160

Type	PA-N160	PA-N300		PA-N540			PA-N1080			PA-N2160			
Diaphragm area	cm ²	160	300		540			1080			2160		
Operating pressure, max.	bar	6	6		6			6			6		
Spring range	bar	1.8 – 3.0	1.6-2.4	1.6-2.8	1.7-2.7	1.7-3.3	1.7-3.7	1.5-2.4	1.5-2.7	1.5-3.0	1.5-2.4	1.5-2.7	1.5-3.0
Spring force	kN	2.8	5	5	9	9	9	16	16	16	32	32	32
Stroke	mm	20	20	30	30	50	60	60	80	100	60	80	100
Volume	ltr.	0.5	1.0	1.3	3.7	4.8	5.3	9.9	12.5	14.2	19.8	25.4	28.5
Stroke volume	ltr.	0.3	0.6	0.8	2.2	3.2	3.8	6.5	8.7	10.8	12.9	17.4	21.6
Air connection		NPT ¼	NPT ¼		NPT ½			NPT ¾			NPT ¾		
Weight without handwheel	kg	6	13		43			120			202		
Weight with handwheel	kg	9	16		62			144			235		

Ambient temperature: -40...+80°C

Operating mode: alternatively spring closes / opens

Actuator variant and accessories

- Manual operating device
- Positioner
 - pneumatic with manometer Type EIP 300
 - pneumatic without manometer Type 2750
 - electro-pneumatic without manometer Type 2750E
 - electro-pneumatic with manometer Type SIPART-PS 2
 - electro-pneumatic with manometer Type SIPART-PS 2-Ex
 - electro-pneumatic with manometer Type SIPART-PS 2
 - electro-pneumatic with manometer Type SIPART-PS 2-Ex
- Air filter, G ¼
- Air filter, G ½
- Blocking valve
- Booster
 - G ¼ Type EIL 100 F02
 - G ¾ Type EIL 100 F03
 - G ¼ or G ½
- Solenoid valve
 - 3/2 Way, 230 VAC, 50 Hz
 - G ¼ Type 6014
- Solenoid valve
 - 3/2 Way, 230 VAC or 24 VDC, 50 Hz
- Quick venting screw
- Throttle
 - G ½ Type 4050306
 - G ¼ Type ID 106123
 - G ½ Type ID 106124
- Limit switches
 - Type 3 SE 2120-1E 1 or 2 pieces

01/06/2009 Data subject to change without notice

3.1.1 Phone +49 (0) 52 07 / 89 03 - 0
4/14 Fax +49 (0) 52 07 / 89 03 - 80
e-Mail b-a@hora.de
Internet www.hora-ba.com

Holter Regelarmaturen GmbH & Co. KG
Helleforthstraße 58-60
33758 Schloß Holte-Stukenbrock
Germany



Excellence is our standard

Control valves with pneumatic actuators up to 350°C

PN 16-40 **3.1.1**

Flanged connection
PN 16-40
Cast iron
Spheroidal graphite
Cast steel
Stainless steel

with pneumatic actuators
PA-N160 • PA-N300 • PA-N540
PA-N1080 • PA-N2160

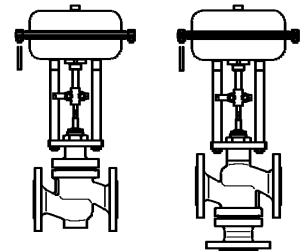

BR216
BR225
BR240S
BR240E

BR316
BR325
BR340S
BR340E

Technical data valve with actuator

PN 16 BR216

DN	125	150	200	250	300	
kvs-value	250	400	630	1000	1250	
	200 ^S	315 ^S	500 ^S	800	1000	
	160	250	400	630	800	
	125 ^{SL}	200 ^{SL}	315 ^{SL}	500 ^L	630 ^L	
Stroke	60			80		
PA-N 1080	Spring range/ Operating pressure		1.5-2.4/6		1.5-2.7/6	
	Δp_s	kPa	1000	700	400	220
PA-N 2160	Spring range/ Operating pressure		1.5-2.4/6		1.5-2.7/6	
	Δp_s	kPa	1600	1500	850	400

100 kPa = 1 bar = 10 mWS
 Δp_s : Closing pressure

PN 16 BR316

DN	125	150	200	250	300	
kvs-value	250	400	630	1000	1250	
	200	315	500	800	1000	
	160 ^S	250 ^S	400 ^S	630	800	
	125 ^S	200 ^S	315 ^S	500	630	
Stroke	60			80		
PA-N 1080	Spring range/ Operating pressure		1.5-2.4/6		1.5-2.7/6	
	Δp_s	kPa	1000	700	400	220
PA-N 2160	Spring range/ Operating pressure		1.5-2.4/6	1.5-2.7/6		
	Δp_s	kPa	850	400	300	

100 kPa = 1 bar = 10 mWS
 Δp_s : Closing pressure

^{L)} Available with perforated plug
^{S)} Special-kvs-value

Control valves with pneumatic actuators up to 350°C

PN 16-40 **3.1.1**

Flanged connection
PN 16-40
Cast iron
Spheroidal graphite
Cast steel
Stainless steel

with pneumatic actuators
PA-N160 • PA-N300 • PA-N540
PA-N1080 • PA-N2160

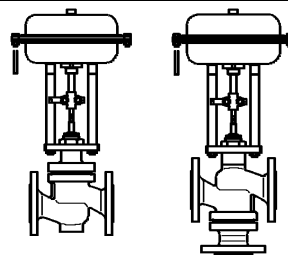

BR216
BR225
BR240S
BR240E

BR316
BR325
BR340S
BR340E

PN 16 / PN 25 / PN 40 BR225

DN		15	15	20	25	32	40	50	65 ¹⁾	80	100 ¹⁾	125 ¹⁾	150 ²⁾	200 ³⁾
kvs-value	m ³ /h	4 ^L	2.5	6.3 ^L	10	16	25	40	63	100	160	250	400	630
		1.6	5 ^{S/L}	8 ^{S/L}	12.5 ^S	20 ^S	31.5 ^S	50 ^S	80 ^S	125 ^S	200 ^S	315 ^S	500 ^S	
		1.25	4 ^L	6.3 ^L	10 ^L	16 ^L	25 ^L	40 ^L	63 ^L	100 ^L	160	250	400	
		1.0	2.5 ^{S/L}	5 ^{S/L}	8 ^{S/L}	12.5 ^{S/L}	20 ^{S/L}	31.5 ^{S/L}	50 ^{S/L}	80 ^{S/L}	125 ^{S/L}	200 ^{S/L}	315 ^{S/L}	
		0.63												
		0.4												
Stroke	mm	20						30		50		60		
PA-N160	Spring range/ Operating pressure	bar	1.8-3.0/6											
	Δp _s	kPa	4000	4000	4000	3500	2200	1400						
PA-N300	Spring range/ Operating pressure	bar	1.6-2.4/6						1.6-2.8/6					
	Δp _s	kPa	4000	4000	4000	4000	3600	2300	1400	900				
PA-N540	Spring range/ Operating pressure	bar							1.7-2.7/6		1.7-3.3/6			
	Δp _s	kPa							3650	2750	1500	900		
PA-N1080	Spring range/ Operating pressure	bar							1.5-2.4/6					
	Δp _s	kPa									1000	700	400	
PA-N2160	Spring range/ Operating pressure	bar							1.5-2.4/6					
	Δp _s	kPa									2250	1550	850	

100 kPa = 1 bar = 10 mWS

Δp_s: Closing pressure

The closing pressure is limited by the nominal pressure.

¹⁾ PN 16 or PN25-40

²⁾ PN 16 or PN25

³⁾ PN 16

^{L)} Available with perforated plug

^{S)} Special-kvs-value

3.1.1
6/14

Phone +49 (0) 52 07 / 89 03 - 0
Fax +49 (0) 52 07 / 89 03 - 80
e-Mail b-a@hora.de
Internet www.hora-ba.com

Holter Regelarmaturen GmbH & Co. KG
Helleforthstraße 58-60
33758 Schloß Holte-Stukenbrock
Germany



Excellence is our standard

Control valves with pneumatic actuators up to 350°C

PN 16-40 **3.1.1**

Flanged connection
 PN 16-40
 Cast iron
 Spheroidal graphite
 Cast steel
 Stainless steel

with pneumatic actuators
 PA-N160 • PA-N300 • PA-N540
 PA-N1080 • PA-N2160

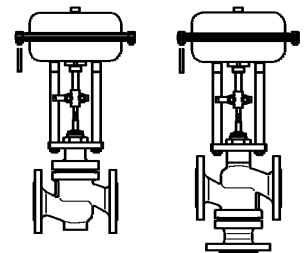

BR216
BR225
BR240S
BR240E

BR316
BR325
BR340S
BR340E

PN 16 / PN 25 / PN 40 BR325

DN		15	20	25	32	40	50	65 ¹⁾	80	100 ¹⁾	125 ¹⁾	150 ²⁾	200 ³⁾	
kvs-value	m ³ /h	4	6.3	10	16	25	40	63	100	160	250	400	630	
		2.5	5	8	12.5	20	31.5	50	80	125	200	315	500	
		4 ^s	4 ^s	6.3 ^s	10 ^s	16 ^s	25 ^s	40 ^s	63 ^s	100 ^s	160 ^s	250 ^s	400 ^s	
		2.5 ^s	2.5 ^s	5 ^s	8 ^s	12.5 ^s	20 ^s	31.5 ^s	50 ^s	80 ^s	125 ^s	200 ^s	315 ^s	
Stroke	mm	20					30		50		60			
PA-N160	Spring range/ Operating pressure	bar	1.8-3.0/6											
	Δp _s	kPa	4000	4000	3500	2200	1400							
PA-N300	Spring range/ Operating pressure	bar	1.6-2.4/5					1.6-2.8/6						
	Δp _s	kPa	4000	4000	4000	3600	2300	1400	900					
PA-N540	Spring range/ Operating pressure	bar						1.7-2.7/6		1.7-3.3/6				
	Δp _s	kPa						3650	2750	1500	900			
PA-N1080	Spring range/ Operating pressure	bar										1.5-2.4/6		
	Δp _s	kPa										1000	700	400
PA-N2160	Spring range/ Operating pressure	bar											1.5- 2.4/6	
	Δp _s	kPa											850	

100 kPa = 1 bar = 10 mWS

Δp_s: Closing pressure

The closing pressure is limited by the nominal pressure.

01/06/2009 Data subject to change without notice

¹⁾ PN 16 or PN25-40

²⁾ PN 16 or PN25

³⁾ PN 16

^{s)} Special-kvs-value

3.1.1 Phone +49 (0) 52 07 / 89 03 - 0
 Fax +49 (0) 52 07 / 89 03 - 80
7/14 e-Mail b-a@hora.de
 Internet www.hora-ba.com

Holter Regelarmaturen GmbH & Co. KG
 Helleforthstraße 58-60
 33758 Schloß Holte-Stukenbrock
 Germany



Excellence is our standard

Control valves with pneumatic actuators up to 350°C

PN 16-40 **3.1.1**

Flanged connection
PN 16-40
Cast iron
Spheroidal graphite
Cast steel
Stainless steel

with pneumatic actuators
PA-N160 • PA-N300 • PA-N540
PA-N1080 • PA-N2160

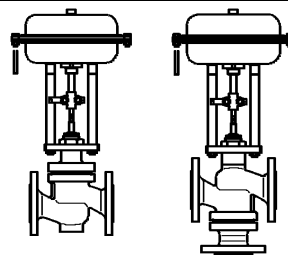

BR216
BR225
BR240S
BR240E

BR316
BR325
BR340S
BR340E

PN 40 BR240S / BR240E

DN	15	15	20	25	32	40	50	65	80	100	125	150	200	250	300		
kvs-value	4 ^L	2.5 1.6 1.25 1.0 0.63 0.4 0.25 0.16	6.3 ^L 5 ^{S/L}	10 8 ^{S/L}	16 12.5 ^S	25 20 ^S	40 31.5 ^S	63 50 ^S	100 80 ^S	160 125 ^S	250 200 ^S	400 315 ^S	630 500 ^S	1000 800	1250 1000		
			4 ^L 2.5 ^{S/L}	6.3 ^L 5 ^{S/L}	10 ^L 8 ^{S/L}	16 ^L 12.5 ^{S/L}	25 ^L 20 ^{S/L}	40 ^L 31.5 ^{S/L}	63 ^L 50 ^{S/L}	100 ^L 80 ^{S/L}	160 125 ^{S/L}	250 200 ^{S/L}	400 315 ^{S/L}	630 500 ^L 400 ^L	1000 800 630 800 630 ^L		
Stroke	mm						20	30	50	60	80						
PA-N 160	Spring range/ Operating pressure	bar	1.8-3.0/6														
	Δp _s	kPa	4000	4000	4000	3500	2200	1400									
PA-N 300	Spring range/ Operating pressure	bar	1.6-2.4/6						1.6-2.8/6								
	Δp _s	kPa	4000	4000	4000	4000	3600	2300	1400	900							
PA-N 540	Spring range/ Operating pressure	bar							1.7-2.7/6		1.7-3.3/6						
	Δp _s	kPa							3650	2750	1500	900					
PA-N 1080	Spring range/ Operating pressure	bar							1.5-2.4/6						1.5-2.7/6		
	Δp _s	kPa							1000						700	400	220
PA-N 2160	Spring range/ Operating pressure	bar							1.5-2.4/6						1.5-2.7/6		
	Δp _s	kPa							2250						1550	850	400

100 kPa = 1 bar = 10 mWS
Δp_s: Closing pressure

^{L)} Available with perforated plug
^{S)} Special-kvs-value

3.1.1 Phone +49 (0) 52 07 / 89 03 - 0
Fax +49 (0) 52 07 / 89 03 - 80
8/14 e-Mail b-a@hora.de
Internet www.hora-ba.com

Holter Regelarmaturen GmbH & Co. KG
Helleforthstraße 58-60
33758 Schloß Holte-Stukenbrock
Germany



Excellence is our standard

Control valves with pneumatic actuators up to 350°C

PN 16-40 **3.1.1**

Flanged connection
PN 16-40
Cast iron
Spheroidal graphite
Cast steel
Stainless steel

with pneumatic actuators
PA-N160 • PA-N300 • PA-N540
PA-N1080 • PA-N2160

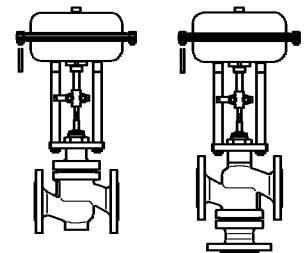

BR216
BR225
BR240S
BR240E

BR316
BR325
BR340S
BR340E

PN 40 R340S / BR340E

DN	15	20	25	32	40	50	65	80	100	125	150	200	250	300			
kvs-value	4	6.3	10	16	25	40	63	100	160	250	400	630	1000	1250			
	2.5	5	8	12.5	20	31.5	50	80	125	200	315	500	800	1000			
		4 ^s 2.5 ^s	6.3 ^s 5 ^s	10 ^s 8 ^s	16 ^s 12.5 ^s	25 ^s 20 ^s	40 ^s 31.5 ^s	63 ^s 50 ^s	100 ^s 80 ^s	160 ^s 125 ^s	250 ^s 200 ^s	400 ^s 315 ^s	630 500	1000 800			
Stroke	mm					20	30	50	60	80							
PA-N 160	Spring range/ Operating pressure	bar					1.8-3.0/6										
	Δp _s	kPa					4000	4000	3500	2200	1400						
PA-N 300	Spring range/ Operating pressure	bar					1.6-2.4/6					1.6-2.8/6					
	Δp _s	kPa					4000	4000	4000	3600	2300	1400	900				
PA-N 540	Spring range/ Operating pressure	bar										1.7-2.7/6		1.7-3.3/6			
	Δp _s	kPa										3650	2750	1500	900		
PA-N 1080	Spring range/ Operating pressure	bar										1.5-2.4/6			1.5-2.7/6		
	Δp _s	kPa										1000	700	400	220	150	
PA-N 2160	Spring range/ Operating pressure	bar													1.5-2.4/6	1.5-2.7/6	
	Δp _s	kPa													850	400	300

100 kPa = 1 bar = 10 mWS

Δp_s: Closing pressure

01/06/2009 Data subject to change without notice

^{s)} Special-kvs-value

3.1.1 Phone +49 (0) 52 07 / 89 03 - 0
Fax +49 (0) 52 07 / 89 03 - 80
9/14 e-Mail b-a@hora.de
Internet www.hora-ba.com

Holter Regelarmaturen GmbH & Co. KG
Helleforthstraße 58-60
33758 Schloß Holte-Stukenbrock
Germany



Excellence is our standard

Control valves with pneumatic actuators up to 350°C

PN 16-40 **3.1.1**

Flanged connection
 PN 16-40
 Cast iron
 Spheroidal graphite
 Cast steel
 Stainless steel

with pneumatic actuators
 PA-N160 • PA-N300 • PA-N540
 PA-N1080 • PA-N2160

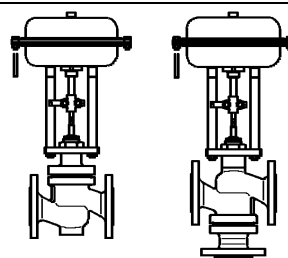

BR216
 BR225
 BR240S
 BR240E

BR316
 BR325
 BR340S
 BR340E

Drawing

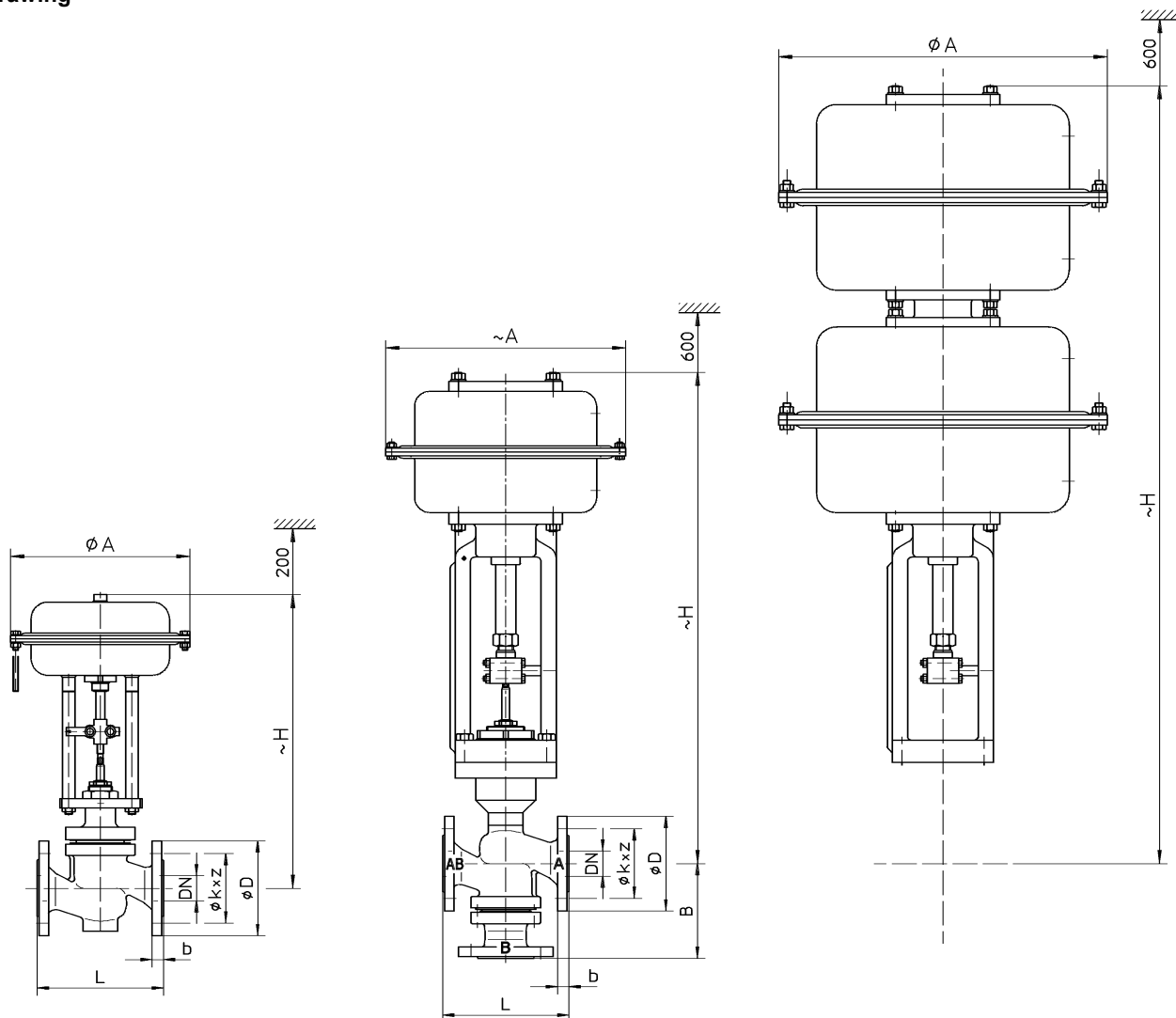

BR2... PA-N160
 PA-N300
 PA-N540
 PA-N1080

BR3... PA-N160
 PA-N300
 PA-N540
 PA-N1080

PA-N2160

Installation instruction:

Valve trim could be damaged by dirt in the pipe system. Therefore we recommend the installation of strainers.

Type		PA-N160	PA-N300	PA-N540	PA-N1080	PA-N2160
A	mm	202	284	380	520	520

01/06/2009 Data subject to change without notice

3.1.1 Phone +49 (0) 52 07 / 89 03 - 0
 Fax +49 (0) 52 07 / 89 03 - 80
 10/14 e-Mail b-a@hora.de
 Internet www.hora-ba.com

Holter Regelarmaturen GmbH & Co. KG
 Helleforthstraße 58-60
 33758 Schloß Holte-Stukenbrock
 Germany



Excellence is our standard

Control valves with pneumatic actuators up to 350°C

PN 16-40 **3.1.1**

Flanged connection
PN 16-40
Cast iron
Spheroidal graphite
Cast steel
Stainless steel

with pneumatic actuators
PA-N160 • PA-N300 • PA-N540
PA-N1080 • PA-N2160

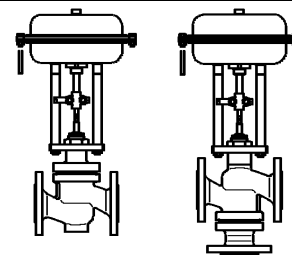

BR216
BR225
BR240S
BR240E

BR316
BR325
BR340S
BR340E

Dimension

BR216 / BR316 and BR225 / BR325

DN		15	20	25	32	40	50	65	80	100	125	150	200 ¹⁾	250 ¹⁾	300 ¹⁾	
L	mm	130	150	160	180	200	230	290	310	350	400	480	600	730	850	
B	mm	130	130	130	150	150	160	170	215	215	260	280	400	450	550	
PN 16	∅ D	mm	95	105	115	140	150	165	185	200	220	250	285	340	405	460
	∅ k	mm	65	75	85	100	110	125	145	160	180	210	240	295	355	410
	z	mm	4x ∅14			4x ∅18			8x ∅18			8x ∅22	12x ∅22	12x ∅26		
	b	mm	16	16	18	18	18	20	20	20	22	24	24	30	32	32
PN 25	∅ D	mm	95	105	115	140	150	165	185	200	235	270	300			
	∅ k	mm	65	75	85	100	110	125	145	160	190	220	250			
	z	mm	4x ∅14			4x ∅18			8x ∅18		8x ∅22	8x ∅26				
	b	mm	16	16	18	18	18	20	20	20	22	24	24			
PA-N160	BR2...	mm	417	417	417	432	432									
	BR3...	mm	372	372	372	392	392									
PA-N300	BR2...	mm	480	480	480	495	495	515	525							
	BR3...	mm	440	440	440	455	455	475	490							
H PA-N540	BR2...	mm						780	785	790	810					
	BR3...	mm						750	765	785	815					
PA-N1080	BR2...	mm										883	908	1023	1228	1288
	BR3...	mm										883	903	1078	1163	1208
PA-N2160	BR2...	mm										1204	1229	1394	1564	1619
	BR3...	mm											1409	1499	1544	

01/06/2009 Data subject to change without notice

¹⁾ PN 16

3.1.1 Phone +49 (0) 52 07 / 89 03 - 0
11/14 Fax +49 (0) 52 07 / 89 03 - 80
 e-Mail b-a@hora.de
 Internet www.hora-ba.com

Holter Regelarmaturen GmbH & Co. KG
 Helleforthstraße 58-60
 33758 Schloß Holte-Stukenbrock
 Germany



Excellence is our standard

Control valves with pneumatic actuators up to 350°C

PN 16-40 **3.1.1**

Flanged connection
PN 16-40
Cast iron
Spheroidal graphite
Cast steel
Stainless steel

with pneumatic actuators
PA-N160 • PA-N300 • PA-N540
PA-N1080 • PA-N2160

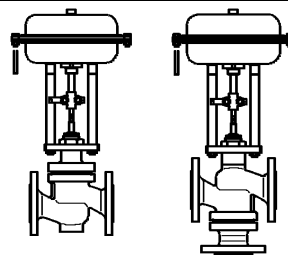

BR216
BR225
BR240S
BR240E

BR316
BR325
BR340S
BR340E

BR240S / BR340S and BR240E / BR340E

DN		15	20	25	32	40	50	65	80	100	125	150	200	250	300	
L	mm	130	150	160	180	200	230	290	310	350	400	480	600	730	850	
B	mm	130	130	130	150	150	160	170	215	215	260	280	400	450	550	
PN 16	∅ D	mm	95	105	115	140	150	165	185	200	220	250	285	340	405	460
	∅ k	mm	65	75	85	100	110	125	145	160	180	210	240	295	355	410
	z	mm	4x ∅14			4x ∅18			8x ∅18			8x ∅22	12x ∅22	12x ∅26		
	b	mm	16	18	18	18	18	20	18	20	20	22	22	24	26	28
PN 25	∅ D	mm	95	105	115	140	150	165	185	200	235	270	300	360	425	485
	∅ k	mm	65	75	85	100	110	125	145	160	190	220	250	310	370	430
	z	mm	4x ∅14			4x ∅18			8x ∅18		8x ∅22	8x ∅26		12x ∅26	12x ∅30	16x ∅30
	b	mm	16	18	18	18	18	20	22	24	24	26	28	30	32	34
PN 40	∅ D	mm	95	105	115	140	150	165	185	200	235	270	300	375	450	515
	∅ k	mm	65	75	85	100	110	125	145	160	190	220	250	320	385	450
	z	mm	4x ∅14			4x ∅18			8x ∅18		8x ∅22	8x ∅26		12x ∅30	12x ∅33	12x ∅33
	b	mm	16	18	18	18	18	20	22	24	24	26	28	34	38	42
PA-N160	BR2...	mm	417	417	417	432	432									
	BR3...	mm	372	372	372	392	392									
PA-N300	BR2...	mm	480	480	480	495	495	515	525							
	BR3...	mm	440	440	440	455	455	475	490							
H PA-N540	BR2...	mm						780	785	790	810					
	BR3...	mm						750	765	785	815					
PA-N1080	BR2...	mm										883	908	1023	1228	1288
	BR3...	mm										883	903	1078	1163	1208
PA-N2160	BR2...	mm										1204	1229	1394	1564	1619
	BR3...	mm											1409	1499	1544	

Control valves with pneumatic actuators up to 350°C

PN 16-40 **3.1.1**

Flanged connection
 PN 16-40
 Cast iron
 Spheroidal graphite
 Cast steel
 Stainless steel

with pneumatic actuators
 PA-N160 • PA-N300 • PA-N540
 PA-N1080 • PA-N2160

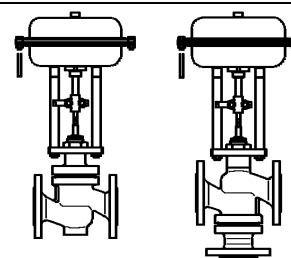

BR216
 BR225
 BR240S
 BR240E

BR316
 BR325
 BR340S
 BR340E

Weight without manual operation

PN16 / PN25

DN			15	20	25	32	40	50	65	80	100	125	150	200	250	300		
m	PA-N 160	BR2... kg	10	12	13	14	17											
		BR3... kg	11	12	14	16	18											
	PA-N 300	BR2... kg	17	19	20	21	24	26	30									
		BR3... kg	18	19	21	23	25	29	33									
	PA-N 540	BR2... kg						56	60	73	85							
		BR3... kg						59	63	77	88							
	PA-N 1080	BR2... kg										181	213	350	435	525		
		BR3... kg										193	224	390	480	585		
	PA-N 2160	BR2... kg										266	298	435	505	595		
		BR3... kg												475	550	655		

PN40

DN			15	20	25	32	40	50	65	80	100	125	150	200	250	300		
m	PA-N 160	BR2... kg	13	14	16	19	20											
		BR3... kg	14	15	17	22	23											
	PA-N 300	BR2... kg	20	21	23	26	27	32	40									
		BR3... kg	21	22	24	29	30	35	46									
	PA-N 540	BR2... kg						62	70	81	96							
		BR3... kg						65	76	88	101							
	PA-N 1080	BR2... kg										187	222	380	500	605		
		BR3... kg										199	241	420	560	685		
	PA-N 2160	BR2... kg										269	323	462	567	672		
		BR3... kg												502	627	752		

01/06/2009 Data subject to change without notice

3.1.1 Phone +49 (0) 52 07 / 89 03 - 0
 Fax +49 (0) 52 07 / 89 03 - 80
13/14 e-Mail b-a@hora.de
 Internet www.hora-ba.com

Holter Regelarmaturen GmbH & Co. KG
 Helleforthstraße 58-60
 33758 Schloß Holte-Stukenbrock
 Germany



Excellence is our standard

Control valves with pneumatic actuators up to 350°C

PN 16-40 **3.1.1**

Flanged connection
PN 16-40
Cast iron
Spheroidal graphite
Cast steel
Stainless steel

with pneumatic actuators
PA-N160 • PA-N300 • PA-N540
PA-N1080 • PA-N2160

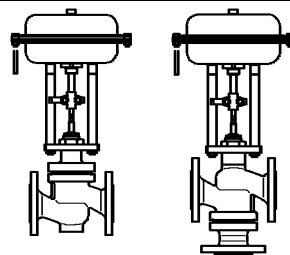

BR216
BR225
BR240S
BR240E

BR316
BR325
BR340S
BR340E

Manual operation

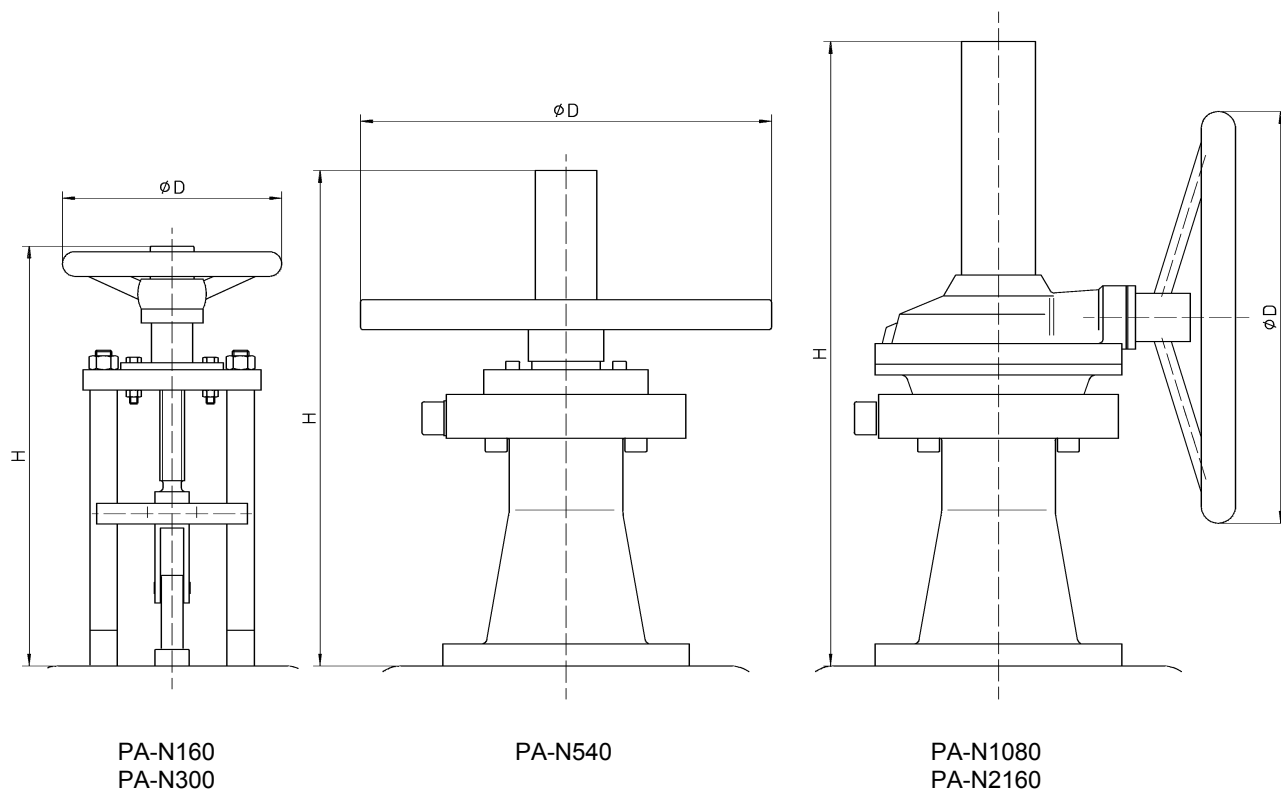

Type		PA-N160	PA-N300		PA-N540		PA-N1080		PA-N2160	
Stroke	mm	20	20	30	30	50	60	80	60	80
H	mm	315	315		361		450		450	
D	mm	175	175		300		400		500	
Weight handwheel	kg	3	3		19		24		33	